



FEM4300/FEM4300D/FEM4300M FEM4300DM Electromagnetic Lock

Electro-Magnetic Lock Description (Indoor, dry use only)

FEM4300: Single magnetic lock, non-monitored, 12/24 VDC

FEM4300D: Double magnetic lock, non-monitored, 12/24 VDC

There is no Lock Status Sensor or Door Status Sensor on the above magnetic locks. For wiring, refer to Figure 1.

FEM4300M: Single magnetic lock, monitored, 12/24 VDC, Lock Status Sensor (LSS), Door Status Sensor (DSS)

FEM4300DM: Double magnetic lock, monitored, 12/24 VDC, Lock Status Sensor (LSS), Door Status Sensor (DSS)

Each monitored magnetic lock has a built-in sensor for remote monitoring of lock status (open or closed) through relay contacts rated at 24 VDC, 1.0 A maximum and a Door Status Sensor (DSS) for remote monitoring of door status through a reed switch contact. For wiring, refer to Figure 2.

LED Indicator OFF	Relay De-energized	No Power on Magnetic Lock
LED Indicator RED	Relay De-energized	Power on Magnetic Lock and Door is Open
LED Indicator GREEN	Relay Energized	Power on Magnetic Lock and Door Locked

Power setting and Input

Power Input	FEM4300 / FEM4300M	FEM4300D / FEM4300DM
12 VDC	0.50 A	2 x 0.50 A
24 VDC	0.25 A	2 x 0.25 A

The (+) lead of the power source is connected to pin 1 (VDC +) of the terminal block and the (-) lead is connected to pin 2 (-). The operating switch or controlling contacts must be installed between the power source and the magnetic lock to reduce operating time of the magnetic lock to a minimum. The electromagnetic lock requires a filtered and regulated DC Power Source for optimal performance. Remove the wiring cavity cover plate and check the position of the two shunts located on the PCB. A single shunt across pins 2 and 3 will set the operating voltage to 24 volts. A shunt between pins 1 to 2 and a shunt between pins 3 to 4 sets the operating voltage to 12 volts.

These voltage shunts must be set correctly before 12 VDC or 24 VDC power is supplied to the Electromagnetic Lock to prevent damage to the unit.

Wiring connections

Figure 1. FEM4300/FEM4300D

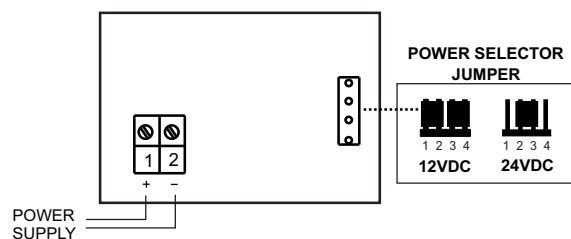
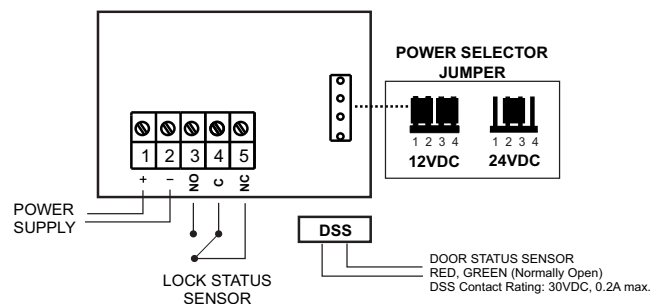

Figure 2. FEM4300M/FEM4300DM



Installation Tips

Armature Plate must remain flexible

The armature plate must remain movable to allow surface alignment with the magnet face. The Magnetic lock will lose holding force without this floating alignment.

Do not trim the rubber washers

Trimming rubber washers will adversely affect the release of the armature plate from the magnetic lock.



FEM4300/FEM4300D/FEM4300M FEM4300DM Electromagnetic Lock

Important Safety Requirements

1. Apply thread-locker glue (e.g., Loctite) to the thread of the Armature-Plate-Fixing Screw (Allen-Screw) to prevent from becoming loose.
2. Locks should be inspected at regular intervals to ensure safe functionality in conjunction with the door environment.
3. The supplied Allen screws cater for maximum door-thickness of 45mm.

Troubleshooting

Problem	Possible Cause	Solution
Door will not lock	No DC voltage to lock. Loose wire on terminal strip.	Check power supply and wiring to magnetic lock. Check for voltage at terminal block of magnetic lock.
Reduced holding force	Bad physical contact between armature plate and face of magnet.	Ensure mating surfaces are clean and in proper alignment and the armature plate floats freely. Check magnetic lock for low voltage or wrong voltage setting.
Delay in door release	Circuit switch is not between magnetic lock and power source.	Re-wire circuit switch between magnetic lock and power source.
LED Status is incorrect	Misalignment of armature plate.	Check alignment of armature plate.
DSS not working	Armature plate is in wrong orientation.	Rotate armature plate. The magnet on the armature plate should be closest to the magnet wiring cover.

Maintenance

Contacting surface of the Electromagnet and Armature plate must be kept free of contaminating materials. Surfaces should be cleaned periodically with a non-abrasive cleaner. Do not spray the Electromagnet or Armature plate surface with any lacquer chemical, this will create problems with the release of the magnetic lock and Armature plate and might cause serious safety problems.

ARMATURE MOUNTING PLATE DETAIL

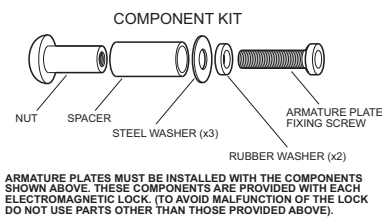

METHODS OF FIXING MAGNETIC LOCKS ON DIFFERENT FRAME PROFILES

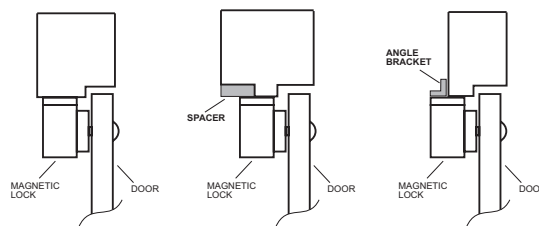

TYPICAL FIXING OF MAGNETIC LOCK ON OUT-SWINGING DOOR

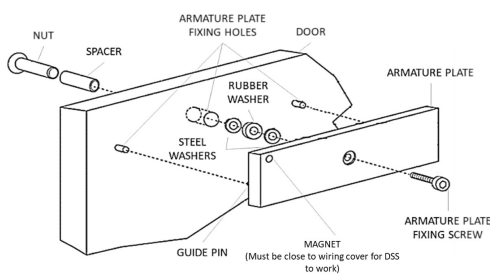
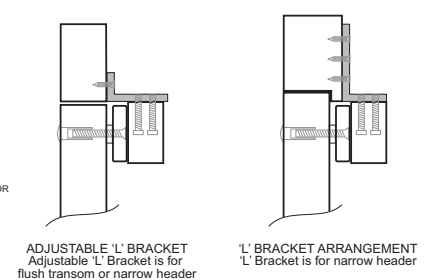

TYPICAL FIXING OF MAGNETIC LOCK ON IN-SWINGING DOOR

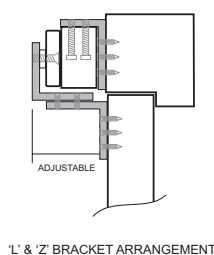

FIXING ARMATURE PLATE ON FRAMELESS GLASS DOORS

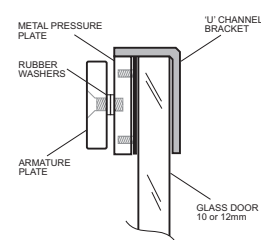

PDFS0001



1800 098 094
info.au@allegion.com
fshlocking.com.au

©Allegion 2021