

# User Manual



**Centurion RT  
PSCERT1000/2000/3000  
Online UPS  
Uninterruptible Power Supply System**



**NetGuard®**

**UPS Monitoring Software**

**IMPORTANT**

**Download the latest NetGuard Monitoring Software:**

**[www.powershield.com.au/index.php/downloads](http://www.powershield.com.au/index.php/downloads)**

**Default password is: administrator**

# Introduction

Thank you for choosing PowerShield.

PowerShield Centurion RT UPS series are designed to provide the highest level of protection against disturbances found on electrical power supply lines. It is suitable for most applications including IT, security, telephone, broadcasting, medical etc.

The Centurion RT UPS series are designed to provide the most comprehensive protection for your valuable electronic equipment, hardware, software and data from harmful disturbances found on AC power lines including blackouts, power sags, power surges, under voltage, over voltage, line noise, frequency variation, switching transients and harmonic distortions. The Centurion RTs true online double conversion topology will continuously protect your equipment by internally isolating your equipment from the utility power ensuring that all your equipment always receives clean, uninterrupted and stable power.

## **Very Important !! : WARRANTY REGISTRATION**

In order to validate product warranty, it is essential that you register your UPS on line.

Please Visit PowerShield on line product warranty web page at

**[www.powershield.com.au/register-products/](http://www.powershield.com.au/register-products/)**

This user manual contains instructions relating to safety, installation, operation, maintenance and warranty of this product.

Please keep this manual in a safe place for future references.

## Special Symbols

The following symbols are used on the UPS to alert you to important information.

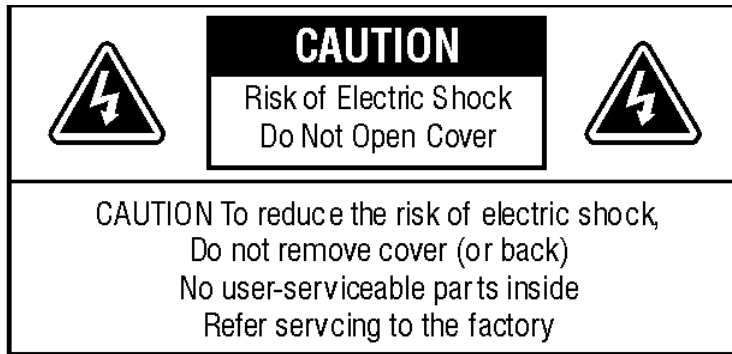

### **RISK OF ELECTRIC SHOCK -**

Indicates that a risk of electric shock is present and the associated warning should be observed



### **CAUTION; REFER TO OPERATOR'S MANUAL -**

Refer to your operator's manual for additional information, such as important operating and maintenance procedures.



### **SAFETY EARTHING TERMINAL -**

Indicates the primary safety ground.

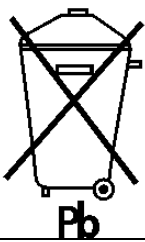

This symbol indicates that you should not discard the UPS or the UPS batteries in the trash. The UPS may contain sealed, lead-acid batteries. Batteries must be recycled.

# Table of Contents

1. Important Safety Warning.....	4
1-1. Transportation .....	4
1-2. Preparation .....	4
1-3. Installation .....	4
1-4. Operation .....	5
1-5. Maintenance, service and faults.....	5
2. Installation and setup.....	6
2-1 Rear panel view.....	6
2-2. Installing the UPS .....	7
2-3. Setting up the UPS.....	8
2-4 Battery Replacement.....	11
2-5 Battery Kit Assembly (option) .....	12
3. Operations.....	13
3-1. Button operation.....	13
3-2. LCD Panel .....	14
3-3. Audible Alarm .....	15
3-4. LCD display wordings index .....	15
3-5. UPS Parameter Settings .....	16
3-6. Operating Mode Description .....	20
3-7. Faults Reference Code.....	21
3-8. Warning indicator .....	21
4. Troubleshooting .....	22
5. Storage and Maintenance .....	23
5-1. Operation .....	23
5-2. Storage .....	23
6. Specifications.....	24

## 1. Important Safety Warning

For safety reasons, it is essential to comply with all warnings and operating instructions listed in this manual. Do not operate the UPS unit before carefully reading through all safety information and operating instructions. It is recommended that you save and or backup this manual for future reference.

### 1-1. Transportation

- Transport the UPS system using only the original packaging to protect against shock and impact.
- **Handling Safety**



Do not lift heavy loads without assistance.



<18 kg



18–32 kg



32–55 kg



>55 kg

This equipment is intended for installation in a controlled temperature indoor area free from conductive contaminants.

### 1-2. Preparation

- The UPS system must be absolutely dry before installation. As condensation may occur if the UPS system is moved directly from cold to warm environments, allow at least two hours for the UPS system to acclimate to the environment.
- Do not install the UPS system near water or in moist environments.
- Do not install the UPS system where it would be exposed to direct sunlight or near heaters.
- Do not block ventilation holes in the UPS housing.

### 1-3. Installation

- Do not connect appliances or devices that may overload the UPS system (e.g. laser printers) to the UPS output sockets.
- To ensure against physical hazards, place cables safely such that persons cannot accidentally trip over or step on them.
- Do not connect domestic appliances such as hair dryers to UPS output sockets.
- The UPS can be operated by any individual without previous experience.
- Always connect the UPS system to an earthed shockproof outlet that is easily accessible and close to the UPS system.
- Use only VDE-tested, CE-marked mains cable (e.g. the mains cable of your computer) to connect the UPS system to the building wiring outlet (shockproof outlet).
- Use only VDE-tested, CE-marked power cables to connect the loads to the UPS system.
- When installing the equipment, ensure that the sum of the leakage currents of the UPS and the connected devices do not exceed 3.5mA.

## 1-4. Operation

- Do not disconnect the mains cable on the UPS system or the building wiring outlet (shockproof socket outlet) during operations as this will cancel and invalidate the protective earth of the UPS system and of all connected loads.
- As the UPS system features its own internal current source (high capacity batteries), the UPS output sockets may be electrically live even if the UPS system is not connected to the building wiring outlet.
- In order to fully disconnect the UPS system, first press the OFF/Enter button to disconnect the mains.
- Prevent fluids or other foreign objects from entering inside the UPS system.

## 1-5. Maintenance, service and faults

- The UPS system operates with hazardous voltages. Repairs should only be carried out by qualified maintenance personnel.
- **Caution** - risk of electric shock. Even after the unit is disconnected from the mains, building wiring outlet, components inside the UPS system are still connected to the battery and electrically live and dangerous.
- Before carrying out any kind of service and/or maintenance; switch off mains power, then disconnect the batteries and verify that no hazardous voltages are present at the terminals of the large storage capacitors (the BUS-capacitors).
- Only persons who are adequately familiar with high capacity batteries, and with the understanding of the required precautionary measures outlined below, are permitted to replace batteries and supervise operations. Unauthorized persons must be kept well away from the batteries.
- **Caution** - risk of electric shock. The battery circuit is not isolated from the input voltage. Hazardous voltages may occur between the battery terminals and the ground. Before touching, always verify that no voltage is present!
- Batteries may cause electric shock and have very high short-circuit currents. When working with batteries always ensure the following precautionary measures are adhered to:
  - remove all jewellery items (wristwatches, rings and metal objects)
  - use only tools with insulated grips and handles.
- When changing batteries, always install the same model and type of batteries.
- Do not attempt to dispose of batteries by burning as they may explode.
- Do not open or destroy batteries. Escaping electrolyte can cause injury to the skin and eyes and may be toxic.
- Replacement fuses must be of the same type and amperage (current rating) in order to avoid fire hazards.
- Do not dismantle the UPS system.

## 2. Installation and setup

**NOTE:** Inspect the unit before installation for any evidence of mistreatment or damage of contents inside the packaging during transport. Store the original package in a safe place for future use.

**NOTE:** There are two different types of online UPS: standard and long-run models. Please refer to the following model table.

Model No.	Type	Model No.	Type
PSCERT1000	Standard	PSCERT1000L	Long-run
PSCERT2000		PSCERT2000L	
PSCERT3000		PSCERT3000L	

### 2-1 Rear panel view

**AC Input - 10Amp IEC  
PSCERT1000(L)**

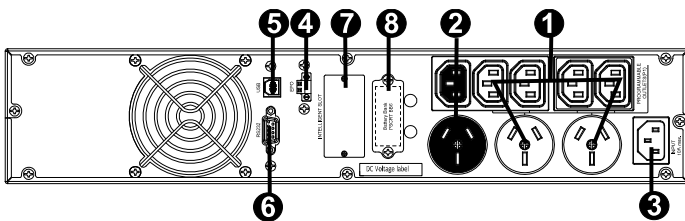

**AC Input - 10Amp IEC  
PSCERT2000**

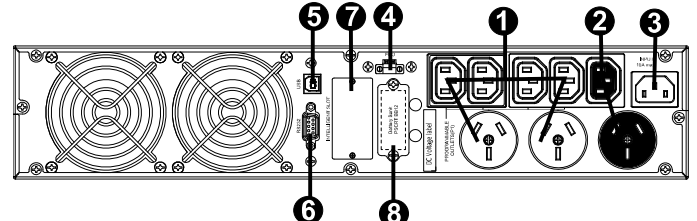

**AC Input - 15 Amp IEC  
PSCERT3000(L)**

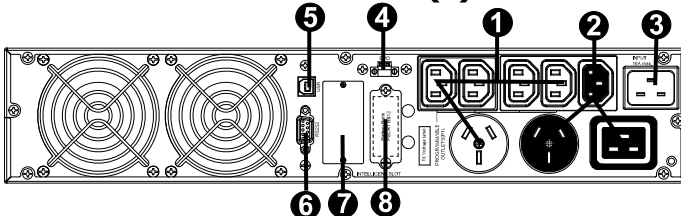

**AC Input - 15 Amp IEC  
PSCERT2000L**

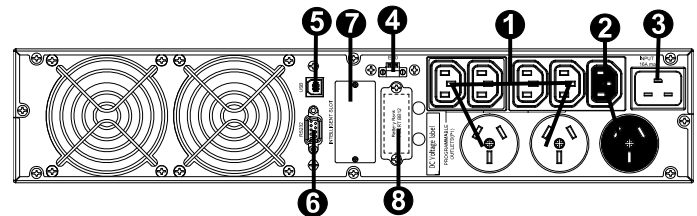

1. Programmable outlets: connect to non-critical loads.
2. Output receptacles: connect to mission-critical loads.
3. AC input
4. Emergency power off function connector (EPO)
5. USB communication port
6. RS-232 communication port
7. SNMP intelligent slot
8. External battery connector

## 2-2. Installing the UPS

The UPS is usually shipped from the factory with the battery wires connected. Note: LCD and alarm will indicate if battery wires are not connected at the start of power up sequence. If not connected, follow the steps below to re-connect the battery wires.

### Step 1

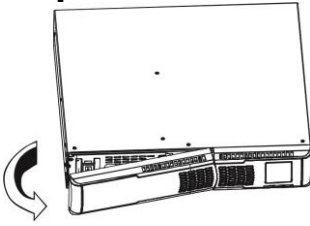

Remove front panel.

### Step 2

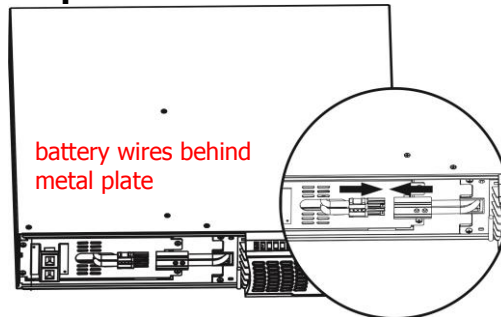

Battery wires are connected behind metal plate. Connect the AC input.

### Step 3

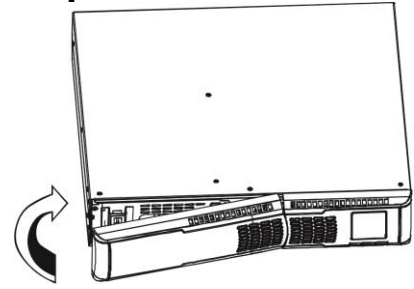

Replace front panel on the unit.

This UPS can be used as either a stand-alone tower or rack mounted in a 19" chassis. Choose from the appropriate installation instructions below to position the UPS accordingly.

## Rack-mount Installation

### Install UPS alone

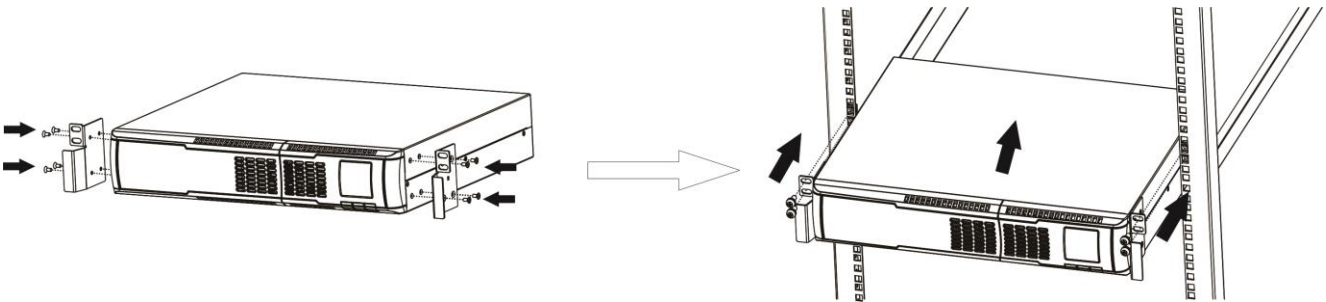

### Install UPS and external battery

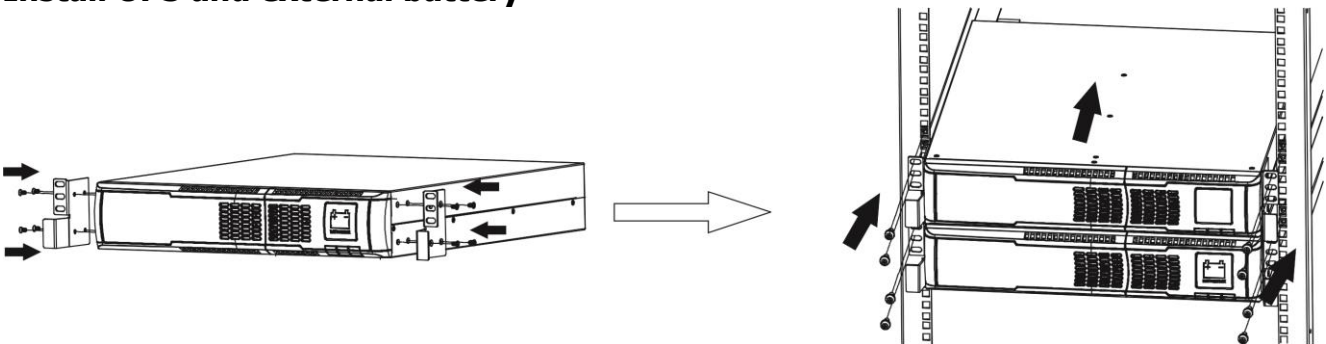

Contact [www.powershield.com.au](http://www.powershield.com.au) on 1300-305-393 for optional PowerShield Rail Kit - PSRK



## Tower Installation

### Step 1

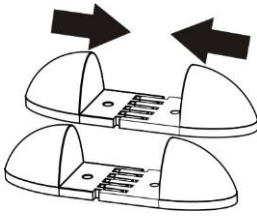

### Step 2

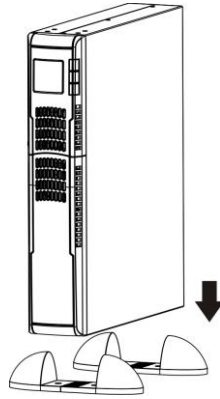

### Step 3

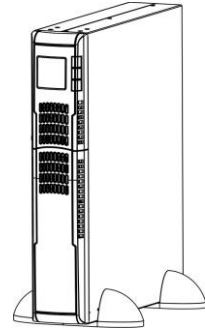

## Install UPS and external battery

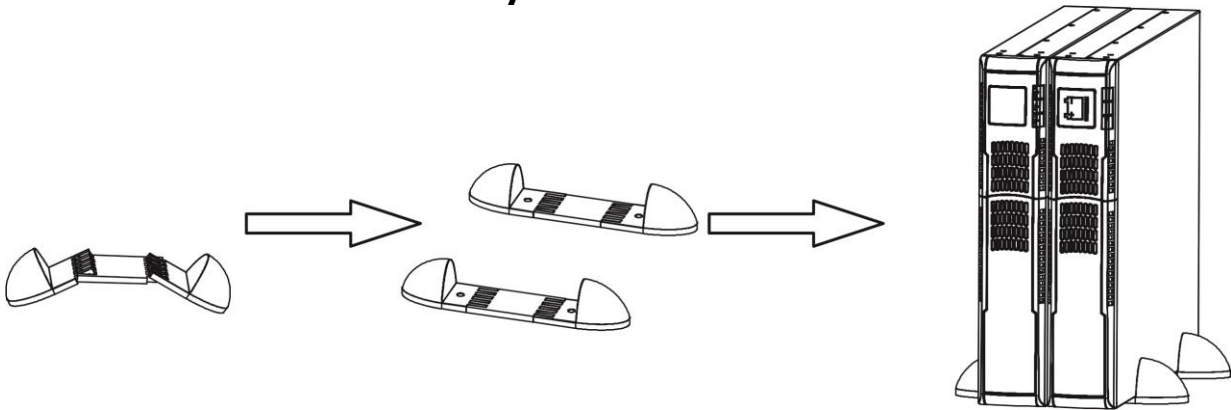

## 2-3. Setting up the UPS

### Step 1: UPS input connection

When connecting the UPS to the mains supply always use a three pin plug, three-wire, grounded receptacle and avoid using extension cords.

### Step 2: UPS output connection

There are two kinds of socket-type outputs: programmable outlets (white coloured outlets) and general outlets (black coloured outlets). Connect non-critical devices to the programmable outlets and critical devices to the general outlets. The backup time to critical devices may be extended during power failure by setting shorter backup time for non-critical devices.

### Step 3: Communication connection

#### Communication port:

##### USB port



##### RS-232 port

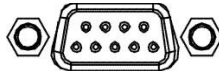

##### Intelligent slot

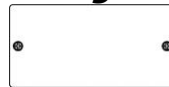

To allow for unattended UPS shutdown/start-up and status monitoring, connect the communication cable on one end to the USB or RS-232 port of the UPS and the other to the USB or RS232 communication port of your PC. With the monitoring software installed, you can

schedule UPS shutdown/start-up and monitor UPS status through the PC.

The UPS is equipped with an intelligent slot to accommodate either an SNMP or AS400 card. When installed, either the SNMP or AS400 card will provide advanced communication and monitoring options for the UPS.

*Please Note: The USB port and RS-232 port can NOT operate at the same time.*

#### Step 4: Disable and enable EPO function

For normal UPS operation, connect pin 1 and pin 2 (closed switch). To activate Emergency Power Off (EPO) function, cut the wire between pin 1 and pin 2 (open switch).

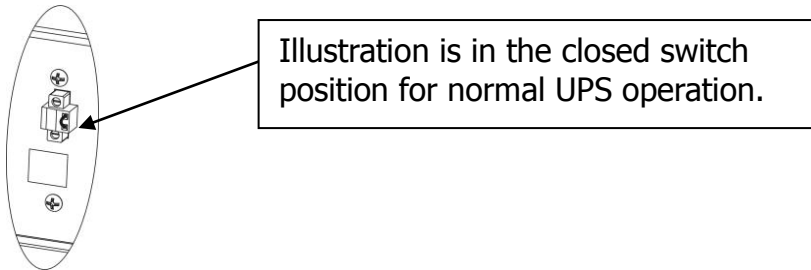

#### Step 5: External Battery Bank connection

Connect the UPS to the first Battery Bank and daisy chain any additional Battery Banks in parallel using the external battery cables provided.

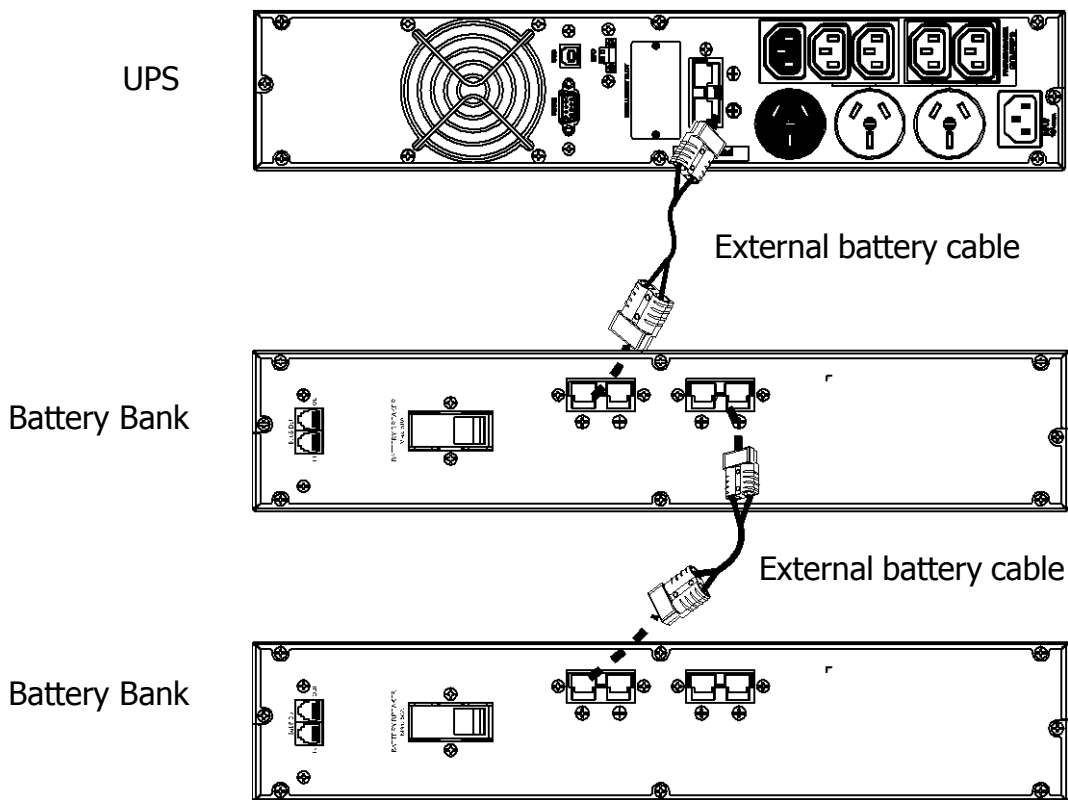

#### BATTERY BANKS

**PSRTBB6 suits PSCERT1000(L)**

**PSRTBB12 suits PSCERT2000(L) and PSCERT3000(L)**

## **Step 6: Turn on the UPS**

Press the ON/Mute button on the front panel for two seconds to power on the UPS.

Note: The battery will fully charge during the first five hours of normal operation. Do not expect full battery run capability during this initial charge period.

## **Step 7: Software Installation**

For optimal computer system protection, install the UPS monitoring software to fully configure UPS shutdown.

Follow the steps below to download and install NetGuard monitoring software:

1. Go to the website [www.powershield.com.au](http://www.powershield.com.au)
2. Click Downloads software icon and choose your required OS to download the NetGuard software in the <http://www.powershield.com.au/downloads/> downloads page.
3. Follow the on-screen instructions to install the NetGuard software.
4. When the computer re-starts, the NetGuard monitoring software will appear as an orange plug icon located in the system tray, near the clock.

## 2-4 Battery Replacement

**NOTICE:** The UPS is equipped with a hot-swappable battery design so the internal batteries can be replaced without shutting down the UPS or connected loads. Replacement is a safe procedure, isolated from electrical hazards.

**CAUTION!!** Consider all warnings, cautions and notes before replacing batteries.

**Note:** The equipment is not protected from power outages during battery disconnection.

### Step 1

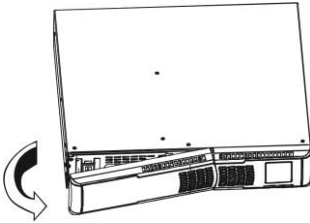

Remove front panel.

### Step 2

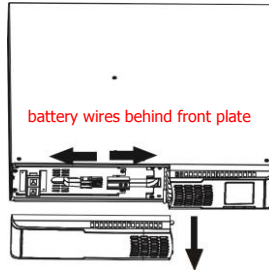

Remove the screws on front plate and remove plate. Disconnect battery wires.

### Step 3

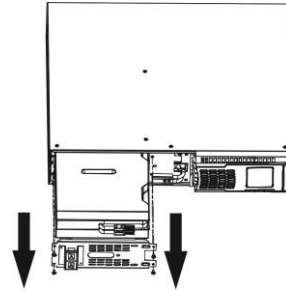

Pull out the battery box.

### Step 4

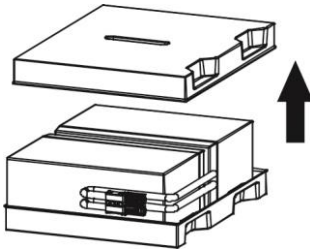

Remove the top cover of battery box and replace the batteries inside.

### Step 5

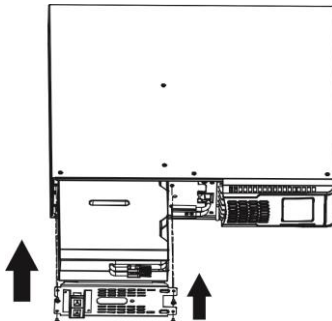

Slide the battery box back in the original location, re-connect the battery wires and fasten the screws on metal cover securely.

### Step 6

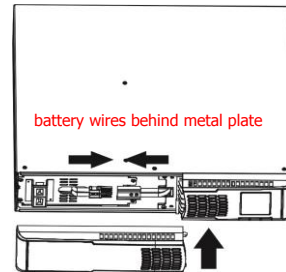

Replace front panel.

### Step 7

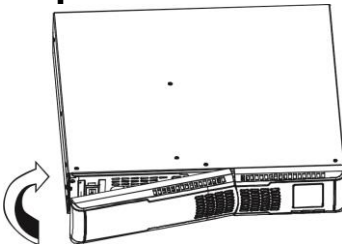

Replace the front panel on the unit.

## 2-5 Battery Kit Assembly (option)

Call Service on **1300-305-393** or contact [www.powershield.com.au](http://www.powershield.com.au) for fully assembled replacement battery kits.

Alternatively, follow the procedures below to assemble new battery kits before replacing used UPS batteries kits.

### 3-battery kit

Step 1: Remove adhesive tapes.

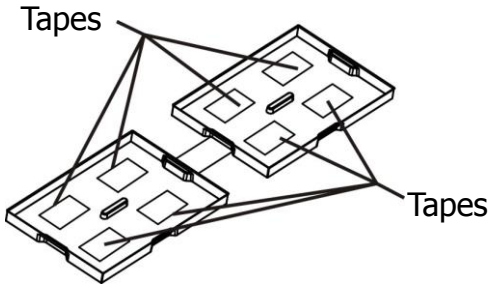

Step 3: Put assembled battery packs on one side of plastic shells and insert one more defect battery on the space.

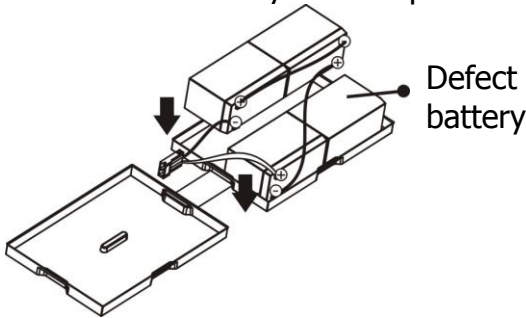

Step 2: Connect all battery terminals by following below chart.

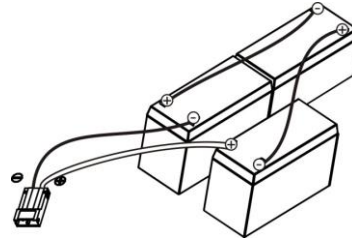

Step 4: Cover the other side of plastic shell as below chart. Then, battery kit is assembly well.

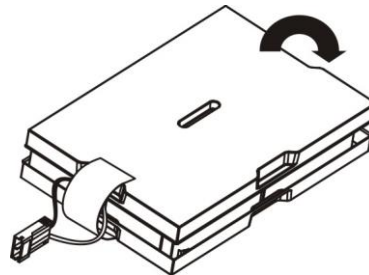

### 6-battery kit

Step 1: Remove adhesive tapes.

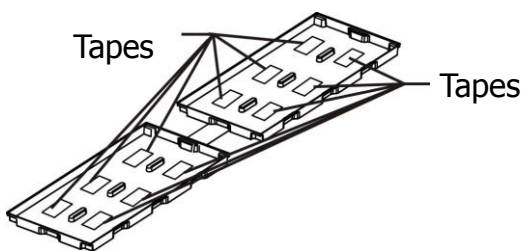

Step 3: Place assembled battery packs on one side of the plastic shells.

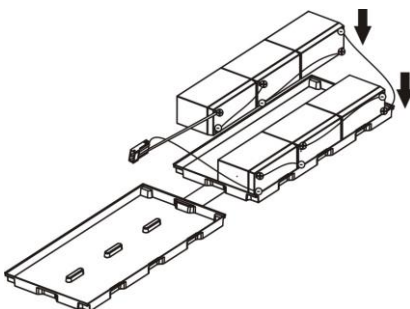

Step 2: Connect all battery terminals by following the chart below.

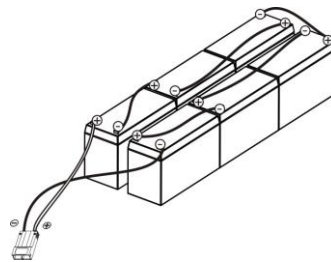

Step 4: Cover the other side of the plastic shell as shown below so that the battery kit assembly is ready for installation.

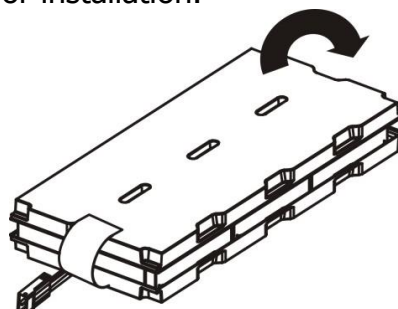

## 3. Operations

### 3-1. Button operation



Button View

Button	Function
ON/Mute Button	<ul style="list-style-type: none"> <li>➤ Turn on the UPS: Press and hold ON/Mute button for at least 2 seconds to turn on the UPS.</li> <li>➤ Mute the alarm: After the UPS is turned on in battery mode, press and hold this button for at least 3 seconds to disable or enable the alarm system. <b>This does not mute other</b> warnings or errors.</li> <li>➤ Up key: Press this button to display previous selection in UPS setting mode.</li> <li>➤ Switch to UPS self-test mode: Press ON/Mute buttons for 3 seconds to enter UPS self-testing while in AC mode, ECO mode, or converter mode.</li> </ul>
OFF/Enter Button	<ul style="list-style-type: none"> <li>➤ Turn off the UPS: Press and hold this button <b>for</b> at least 2 seconds to turn off the UPS. UPS will <b>switch off to</b> standby mode under normal <b>power</b> or transfer to Bypass mode if the Bypass setting <b>has been enabled</b>.</li> <li>➤ Confirm selection key: Press this button to confirm selection in UPS setting mode.</li> </ul>
Select Button	<ul style="list-style-type: none"> <li>➤ Switch LCD message: Press this button to change the LCD message for input voltage, input frequency, battery voltage, output voltage and output frequency.</li> <li>➤ Setting mode: Press and hold this button for 3 seconds to enter UPS setting mode when <b>in</b> Standby <b>or</b> Bypass mode.</li> <li>➤ Down key: Press this button to display next selection in UPS setting mode.</li> </ul>
ON/Mute + Select Button	<ul style="list-style-type: none"> <li>➤ Switch to bypass mode: When the main power is normal, press ON/Mute and Select buttons simultaneously for 3 seconds. Then UPS will enter bypass mode. This action will be ineffective when the input voltage is out of acceptable range.</li> <li>➤ Exit setting mode or return to the upper menu: When working in setting mode, press ON/Mute and Select buttons simultaneously to return to the upper menu. If it's already in top menu, press these two buttons at the same time to exit the setting mode.</li> </ul>

### 3-2. LCD Panel

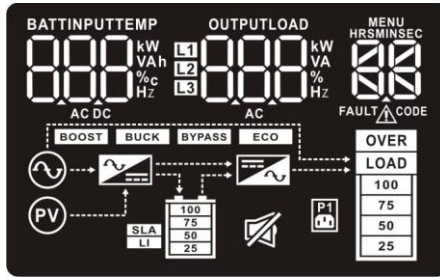

Display	Function
	Indicates the remaining backup time in numbers or digits. HRS: hours, MIN: minutes, SEC: seconds
<b>Warning &amp; Fault information</b>	
	Indicates that a warning and fault occurs.
	Indicates the warning and fault codes as listed in detail in section 3-7 and 3-8.
<b>Setting Operation</b>	
	Indicates the setting operation.
<b>Battery, Input, Temperature, Output and Load information</b>	
	Indicates the input voltage, input frequency, battery voltage, battery capacity and ambient temperature. k: kilo, W: watt, V: voltage, A: ampere, %: percent, °C: centigrade degree, Hz: frequency, AC: alternating current, DC: direct current
	Indicate the output voltage, output frequency, load current and load percentage. k: kilo, W: watt, V: voltage, A: ampere, %: percent, Hz: frequency, AC: alternating current
<b>Load information</b>	
	Indicates the load level by 0-24%, 25-49%, 50-74%, and 75-100%.
	Indicates overload.
<b>UPS status</b>	
	Indicates that programmable management outlets are working.
	Indicates the UPS alarm is disabled.
	Indicates the UPS is working in bypass mode.
	Indicates the UPS powers the output directly from the mains
	Indicates the UPS connects to the mains.
	Indicates the UPS connects to the PV
	Indicates the AC to DC circuit is working
	Indicates the inverter circuit is working
<b>Battery information</b>	
	Indicates the Battery level by 0-24%, 25-49%, 50-74%, and 75-100%.

### 3-3. Audible Alarm

Battery Mode	2 beeps every 30 seconds
Bypass Mode	1 beep every 10 seconds
Low Battery	Rapid one beep every second
Overload	2 short beeps every 2 seconds
Fault	Continuously sounding

### 3-4. LCD display wordings index

Abbreviation	Display content	Meaning
ENA	ENR	Enable
DIS	diS	Disable
CF	CF	Constant Frequency Constant Voltage
BAT	bAt	Battery
HLS	HLS	High loss
LLS	LLS	Low loss
BAH	bAH	Battery AH
CHA	CHr	Charger current
CBV	CBV	Charger boost voltage
CBF	CFV	Charger float voltage
AUT	Aut	Automatic
AON	AON	Always on
ESC	ESC	Escape
ON	ON	ON
OK	OK	OK
EP	EP	EPO
TP	TP	Temperature
CH	CH	Charger
BF	bF	Battery Fault
FU	FU	Bypass frequency unstable
BR	bR	Battery Replace
EE	EE	EEPROM error



### 3-5. UPS Parameter Settings

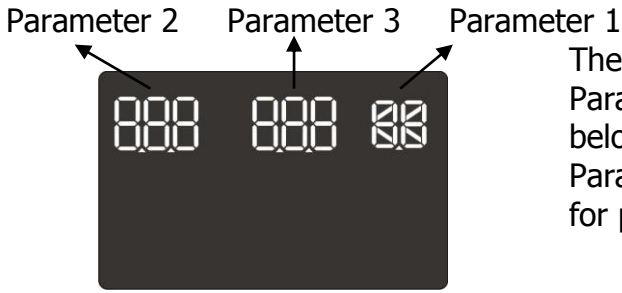

There are three parameters to set up the UPS.  
 Parameter 1: It's for program alternatives. Refer to below table.  
 Parameter 2&3: It's is the setting options or values for program.

● 01: Output voltage setting

Interface	Setting
	For 200/208/220/230/240 VAC models, you may choose the following output voltage: 200: sets output voltage to 200Vac 208: sets output voltage to 208Vac 220: sets output voltage to 220Vac 230: sets output voltage to 230Vac 240: sets output voltage to 240Vac (Default setting)

● 02: Frequency Converter enable/disable

Interface	Setting
	CF ENA: converter mode enable CF DIS: converter mode disable (Default setting)

● 03: Output frequency setting

Interface	Setting
	The frequency may be set in battery mode: BAT 50: sets output frequency to 50Hz BAT 60: sets output frequency to 60Hz If converter mode is enabled, output frequency can be selected: CF 50: sets output frequency to 50Hz CF 60: sets output frequency to 60Hz

● 04: ECO enable/disable

Interface	Setting
	ENA: ECO mode enable DIS: ECO mode disable (Default setting)

● 05: ECO voltage range setting

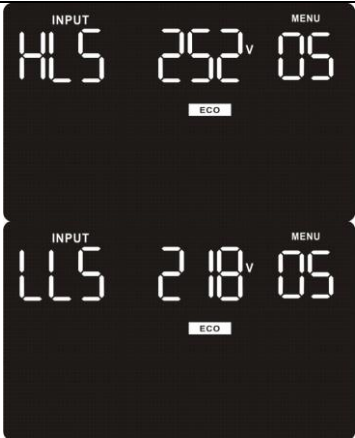
Interface	Setting
	<p>Parameter 1 &amp; 2: Set the acceptable high voltage point and low voltage point for ECO mode by pressing Down key or Up key.            HS: High loss voltage in ECO mode in parameter 2.            The setting range in parameter 3 is from +7V to +24V of the nominal voltage. (Default: +12V)            LS: Low loss voltage in ECO mode in parameter 2.            The setting range in parameter 3 is from -7V to -24V of the nominal voltage.            (Default: -12V)</p>

● 06: Bypass enable/disable when UPS is off

Interface	Setting
	<p>Parameter 2: Enable or disable Bypass function. You may choose the following two options:            ENA: Bypass enable            DIS: Bypass disable (Default setting)</p>

● 07: Bypass voltage range setting

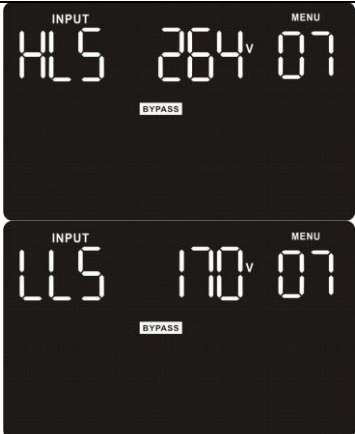
Interface	Setting
	<p>Parameter 1 &amp; 2: Set the acceptable high voltage point and acceptable low voltage point for Bypass mode by pressing the Down key or Up key.            HS: Bypass high voltage point            230-264: setting the high voltage point in parameter 3 from 230Vac to 264Vac. (Default: 264Vac)            LS: Bypass low voltage point            170-220: setting the low voltage point in parameter 3 from 170Vac to 220Vac (Default: 170Vac)</p>

● 08: Bypass frequency range setting

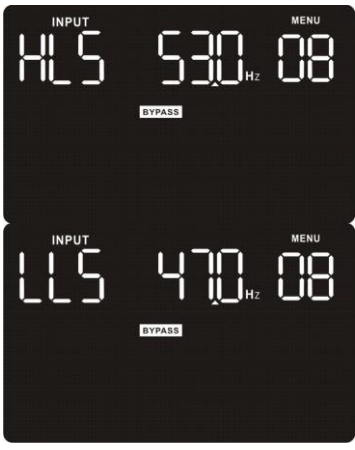
Interface	Setting
	<p>Parameter 1 &amp; 2: Set the acceptable high frequency point and acceptable low frequency point for Bypass mode by pressing the Down key or Up key.            HS: Bypass high frequency point            For 50Hz output frequency models:            51-55Hz: setting the frequency low loss point from 51Hz to 55Hz (Default: 53.0Hz)            For 60Hz output frequency models:            61-65Hz: setting the frequency low loss point from 61Hz to 65Hz (Default: 63.0Hz)            LS: Bypass low Frequency point            For 50Hz output frequency models:</p>

	<p>45-49Hz: setting the frequency low loss point from 45Hz to 49Hz(Default: 47.0Hz)  For 60Hz output frequency models:  55-59Hz: setting the frequency low loss point from 55Hz to 59Hz(Default: 57.0Hz)</p>
--	----------------------------------------------------------------------------------------------------------------------------------------------------------------------------------------------------------------------

● 09: Programmable outlets enable/disable

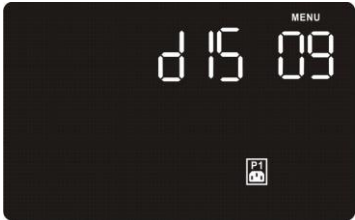
Interface	Setting
	<p>Parameter 2: Enable or disable programmable outlets.  ENA: Programmable outlets enable  DIS: Programmable outlets disable (Default setting)</p>

● 10: Programmable outlets setting

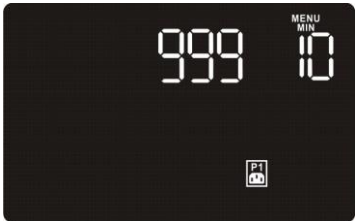
Interface	Setting
	<p>Parameter 2: Set up backup time limits for programmable outlets.  0-999: setting the backup time limits in minutes from 0-999 for programmable outlets which connect to non-critical devices on battery mode. (Default: 999)</p>

● 11: Autonomy limitation setting

Interface	Setting
	<p>Parameter 2: Set up backup time on battery mode for general outlets.  0-999: setting the backup time in minutes from 0-999 for general outlets on battery mode.  DIS: Disable the autonomy limitation and the backup time will depend on battery capacity. (Default)  Note: When setting as "0", the backup time will be only 10 seconds.</p>

● 12: Battery total AH setting

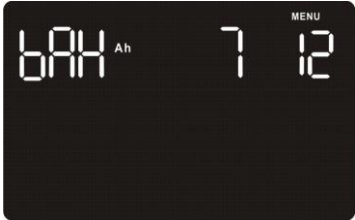
Interface	Setting
	<p>Parameter 2: Set up the battery total AH of the UPS.  7-999: setting the battery total capacity from 7-999 in AH. Please set the correct battery total capacity if external battery bank is connected.</p>

● 13: Charger maximum current setting

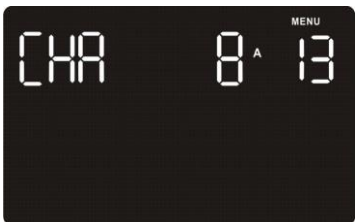
Interface	Setting
	<p>Parameter 2: Set up the charger maximum current.  1/2/4/6/8: setting the charger maximum current 1/2/4/6/8 in Ampere. (Default: 8A)  Note: the setting is only effective for super charger</p>

- 14: Charger Boost voltage setting

Interface	Setting
	Parameter 2: Set up the charger boost voltage. 2.25-2.40: setting the charger boost voltage from 2.25 to 2.40(unit: 1V/cell). (Default: 2.36)

- 15: Charger Float voltage setting

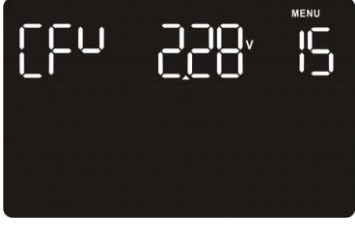
Interface	Setting
	Parameter 2: Set up the charger float voltage. 2.20-2.33: setting the charger float voltage from 2.20 to 2.33(unit: 1V/cell). (Default:2.28)

- 16: LCD display backlight setting

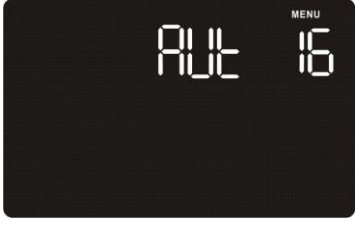
Interface	Setting
	Aon: LCD display backlight is on all the time. Aut: LCD display backlight will turn off after 60 seconds if no buttons are pressed. (Default setting)

- 00: Exit setting

Interface	Setting
	Exit the setting mode.

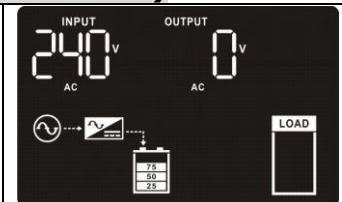

### 3-5-1 Steps for setting programmable outlet ( White Coloured Outlets )

**Step 1:** Before entering setting mode, ensure the UPS is in either Bypass or Stand-by mode (off-charging) and make sure the battery is connected. The LCD display is shown at right.

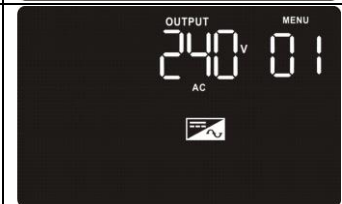

**Step 2:** Press and hold the "Select" button for 3 seconds to enter Setting mode.

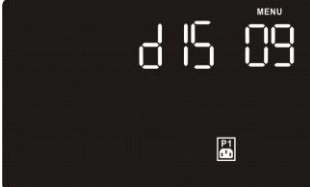

<p><b>Step 3:</b> Press the "Up" button (ON/MUTE) to switch to "09" of program list. Then press "Enter" button to enter value setting of parameter 2. Press the "Up" button to change the value to "ENA" to enable the programmable outlet function. Then press "Enter" button again to confirm the setting.</p>	
<p><b>Step 4:</b> Press the "Up" button (ON/MUTE) again to switch to "10" of program list. Then press "Enter" button for setting programmable outlet time. Push "Up" button to change the value of backup time according to your demand. Then press "Enter" to confirm the setting.</p>	
<p><b>Step 5:</b> Press "Up" button (ON/MUTE) to switch to "00" of program list. Then press "Enter" button to exit setting menu.</p>	
<p><b>Step 6:</b> Disconnect AC input and wait until the LCD display is off. The new setting will be activated when the UPS is turned on again.</p>	

### 3-6. Operating Mode Description

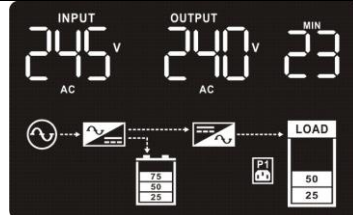
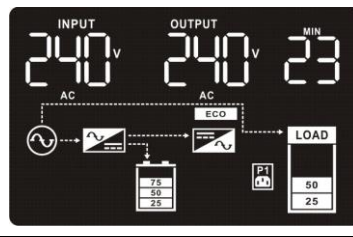
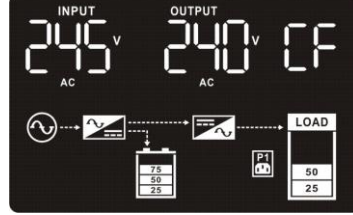
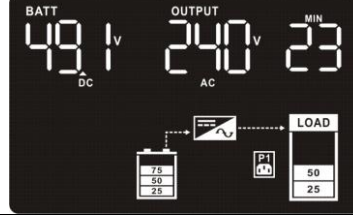
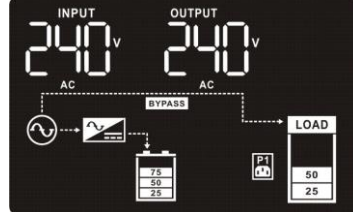

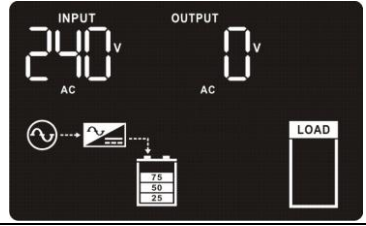
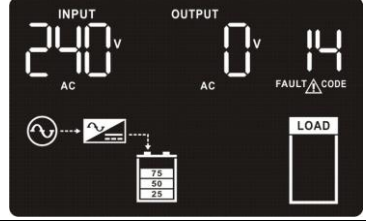







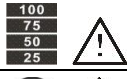

Operating mode	Description	LCD display
Online mode	When the input voltage is within acceptable range, UPS will provide pure and stable AC power to output. The UPS will also charge the battery in online mode.	
ECO mode (Efficiency Corrective Optimizer)	When the input voltage is within setting range ( $\pm 3\%V_o$ ), UPS will bypass voltage to output for energy saving. PFC and INVERTER are still active in this mode.	
Frequency Converter mode	When input frequency is within 40 Hz to 70 Hz, the UPS can be set at a constant output frequency of 50 Hz or 60 Hz. The UPS will still charge the battery in this mode.	
Battery mode	When the input voltage is beyond the acceptable range or power failure and alarm is sounding 2 beeps every 30 seconds, UPS will backup power from the battery.	
Bypass mode	When input voltage is within acceptable range but UPS is in overload, UPS will enter bypass mode or bypass mode can be set by front panel. Alarm is sounding every 10 seconds.	

Standby mode	UPS is powered off without providing output power, but the battery is still being charged.	
Fault mode	The UPS is in fault mode when no output power is supplied from the UPS and the fault icon flashes on the LCD display. The UPS status information continues to be displayed on the screen.	

### 3-7. Faults Reference Code







Fault event	Fault code	Icon	Fault event	Fault code	Icon
Bus start fail	01	x	Inverter output short	14	x
Bus over	02	x	Battery voltage too high	27	x
Bus under	03	x	Battery voltage too low	28	x
Inverter soft start fail	11	x	Over temperature	41	x
Inverter voltage high	12	x	Over load	43	
Inverter voltage Low	13	x	Charger failure	45	x

### 3-8. Warning indicator

Warning	Icon (flashing)	Alarm
Low Battery		Rapid one beep every second
Overload		2 short beeps every 2 seconds
Battery is not connected		2 short beeps every 2 seconds
Overcharge		Continuously sounding
Site wiring fault		2 short beeps every 2 seconds
EPO enable	EP 	2 short beeps every 2 seconds
Over temperature	EP 	Continuously sounding
Charger failure	CH 	Continuously sounding
Battery Fault	BF 	Continuously sounding <i>(At this time, UPS is off to remind users of something wrong with battery)</i>
Bypass Out Range		2 short beeps every 2 seconds
Bypass Frequency Unstable	FU 	2 short beeps every 2 seconds
Replace Battery	BR 	2 short beeps every 2 seconds
EEPROM error	EE 	2 short beeps every 2 seconds

## 4. Troubleshooting

Use the table below to diagnose the UPS system for symptoms and problems.

Symptom	Possible cause	Remedy
No indication and alarm even though the mains supply is normal.	The AC input power is not connected well.	Check if input power cord firmly connected to the mains.
	The AC input is connected to the UPS output.	Plug AC input power cord to AC input correctly.
The icon  and the warning code <b>EP</b> flashing on LCD display and alarm is sounding 2 short beeps every 2 seconds.	EPO function is activated.	Set the circuit in closed position to disable EPO function.
The icon  and  flashing on LCD display and alarm is sounding 2 short beeps every 2 seconds.	Line and neutral conductors of UPS input are reversed.	Check mains power socket and or building wiring and then reconnect to UPS system.
The icon  and  flashing on LCD display and alarm is sounding 2 short beeps every 2 seconds.	The external or internal battery is incorrectly connected.	Check if all batteries are connected well.
Fault code is shown as 27 on LCD display and alarm is continuously sounding.	Battery voltage is too high or the charger is faulty.	Contact your dealer.
Fault code is shown as 28 on LCD display and alarm is continuously sounding.	Battery voltage is too low or the charger is faulty.	Contact your dealer.
The icons of  and <b>OVER LOAD</b> are flashing on LCD display and alarm is sounding 2 short beeps every 2 seconds.	UPS is overloading	Remove excess loads from UPS output.
	UPS is overloaded. Devices connected to the UPS are fed directly by the electrical network via the Bypass.	Remove excess loads from UPS output.
	After repetitive overloads, the UPS is locked in the Bypass mode. Connected devices are fed directly by the mains.	Remove excess loads from UPS output first. Then shut down the UPS and restart it.
Fault code is shown as 43 and The icon <b>OVER LOAD</b> is lighting on LCD display and alarm is continuously sounding.	The UPS shut down automatically because of overload at the UPS output.	Remove excess loads from UPS output and restart it.
Fault code is shown as 14 and alarm is continuously sounding.	The UPS shut down automatically because short circuit occurs on the UPS output.	Check output wiring and if connected devices are in short circuit status.

Symptom	Possible cause	Remedy
Fault code is shown as 01, 02, 03, 11, 12, 13 and 41 on LCD display and alarm is continuously sounding.	A UPS internal fault has occurred. There are two possible results: 1. The load is still supplied, but directly from AC power via bypass. 2. The load is no longer supplied.	Contact your dealer
Battery backup time is shorter than nominal value	Batteries are not fully charged	Charge the batteries for at least 5 hours and then check capacity. If the problem still persists, consult your dealer.
	Battery defect	Contact your dealer to replace the batteries.
Fault code is shown as 45 on LCD display. At the same time, alarm is continuously sounding.	No output from charger and battery voltage is less than 10V/PC.	Contact your dealer.

## 5. Storage and Maintenance

### 5-1. Operation

The UPS system contains no user-serviceable parts. Please contact your dealer if the battery service life (3~5 years at 25°C ambient temperature) has been exceeded, as the batteries must be replaced.



Be sure to deliver the spent battery to a recycling facility or ship it to your dealer in the replacement battery packing material.

### 5-2. Storage

Before storing, charge the UPS for 5 hours. Store the UPS covered and upright in a cool, dry location. During storage, recharge the battery in accordance with the following table:

Storage Temperature	Recharge Frequency	Charging Duration
-25°C - 40°C	Every 3 months	1-2 hours
40°C - 45°C	Every 2 months	1-2 hours



## 6. Specifications

### CENTURION RT RANGE SELECTION GUIDE

MODEL	CENTURION RT 1000 & 1000 (L)	CENTURION RT 2000 (SB)	CENTURION RT 2000 & 2000 (L)	CENTURION RT 3000 & 3000 (L)	RT BATTERY BANKS				
Model Number	PSCERT1000/PSCERT1000L	PSCERT2000SB	PSCERT2000/PSCERT2000L	PSCERT3000/PSCERT3000L	PSRTBB6	PSRTBB8	PSRTBB12		
Capacity	1000VA/900W	2000VA/1800W		3000VA/2700W	Suits PSCERT1000	Suits PSCERT2000SB	Suits PSCERT2000/PSCERT3000		
Topology	True online double- conversion, Pure Sine Wave								
<b>INPUT</b>									
Voltage Range	Low Line Transfer	160Vac / 140Vac / 120 / 110Vac $\pm$ 5 % (based on load percentage 100%-80% / 80%-70% / 70%-60% / 60%-0)							
	Low Line Comeback	175Vac / 155Vac / 135Vac / 125Vac $\pm$ 5 %							
	High Line Transfer	300Vac $\pm$ 5 %							
	High Line Comeback	290Vac $\pm$ 5 %							
Frequency Range	40Hz - 70Hz								
Phase	Single phase with ground								
Power Factor Correction	$\geq$ 0.99 @ nominal voltage (100% load)								
<b>OUTPUT</b>									
Output Power Factor	0.9								
Output Voltage (AC Mode)	240Vac (Selectable 200/208/220/230/240Vac)								
Voltage Regulation (Batt. Mode)	$\pm$ 1%								
Frequency Range (Batt. Mode)	50Hz or 60Hz $\pm$ 1Hz								
Current Crest Ratio	3:1 (max.)								
Transfer	AC Mode to Batt. Mode	Zero							
	Inverter to Bypass	4ms (Typical)							
Waveform (Batt. Mode)	Pure Sine Wave								
<b>EFFICIENCY</b>									
ECO Mode (Advanced)	96%	97%		97%					
Battery Mode	86%	87%		87%					
<b>BATTERY</b>									
Battery Number (12 V*9AH)	x 3	x 4	x 6	x 6	2 x 3	2 x 4	2 x 6		
Typical Recharge Time	4 hours recover to 90% capacity (for standard model only)								
Charging Current (max.)	Standard Models - 1.5Amp. Long Run Models - 1Amp / 2Amp / 4Amp / 8Amp selectable (factory default is 8Amp)								
<b>PROTECTION</b>									
Full Protection	Overload, discharge, thermal, short circuit and overcharge protection								
Surge Protection	984 Joules / 22000 Amps								
<b>COMMUNICATIONS AND MANAGEMENT</b>									
Interface	USB or RS232 as standard, Intelligent slot for PSSNMP, PSMODbus or PSAS400 dry contact								
Software	PowerShield® NetGuard® software - supports Windows based operating systems, Linux, Unix and Mac								
LCD Display/Alarm	UPS Status, Load & Battery Level, Input/Output Voltage, Batt. Time Remaining and Fault Indicators								
Audible Alarm	Battery Mode, Bypass Mode, Low Battery (Batt. Mode), Fault, Overload								
<b>PHYSICAL</b>									
Dimension, (D x W x H) mm	400 x 438 x 88	500 x 438 x 88	620 x 438 x 88	620 x 438 x 88	500 x 438 x 88	500 x 438 x 88	620 x 438 x 88		
Weight (kg)	15.2	8.4	19.5	25.6	12.8	26.8	25	29	42
<b>OPERATING ENVIRONMENT</b>									
Temperature	0 - 40°C								
Humidity	20 - 90% (RH Non-condensing)								
Noise Level	< 50dBA @ 1 Meter								
<b>COMPLIANCE</b>									
Safety / EMC / RoHS	EN62040-1-1 2003, IEC60950-1-1 / EN62040-2 2006 / Directive 2011/65/EU								

\* Specifications are subject to change without prior notice. \* Models ending in "L" are long run models with larger chargers and therefore have no internal batteries

**Power Shield Pty Ltd Warranty Terms & Conditions** (PSW28012012)

**SERVICE / WARRANTY (Australia)**  
**(Tel) 1300-305-393**

**Warranty Conditions**

1. Power Shield products are warranted for certain specified period (see item 15 below) against failure due to faulty materials or workmanship from the invoice date from the Power Shield Store. Power Shields products are covered by a warranty in addition to all rights available to you by statute.
2. If, within the warranty period, the product does not meet the specification above and the product was installed and operated in accordance with Power Shield and Australian standards and procedures, then Power Shield will, correct any defects due to material or workmanship.
3. If the product has been modified, recalibrated, repaired, opened or tampered with in any way by the customer then its warranty will be void.
4. If the product has been damaged during transport then warranty will be void.
5. If product failed due to fire, earthquake, flood, direct lightning strike, terrorism, pollution, exposed under poison gas, and incorrect utility voltage then warranty will be void.
6. Batteries must be operated within the technical specification limits of the manufacturer and must be fully re-charged at least every three months during storage.
7. If Power Shield at its sole discretion determines that the product has failed, under Power Shield warranty conditions then Power Shield will at its option repair or replace the faulty unit
8. Power Shield will, at its sole discretion, replace the faulty product with an equal or equivalent model of a similar age and condition.
9. If the product, has failed due to reasons that Power Shield at its sole discretion, determines to be outside of warranty conditions, or is found to be not faulty then a minimum inspection and handling fee will be charged and also freight will be for the customer's account.
10. Blown fuses are usually as a result of overload and are not considered a warranty condition and a handling and inspection charge will apply as above
11. For hardwired products, larger than 3KVA, the warranty covers onsite repair for metro areas in capital cities only. For equipment installed in remote locations Power Shield may, at its sole discretion, request that the product be returned to a Power Shield service centre at the customer's cost,
12. Power Shield UPS products are not failsafe devices. Although well designed and manufactured, like all electrical, electronic and mechanical devices it has the potential to fail. This should be taken into consideration when designing any critical system
13. Subject to the applicable Law, in no event shall Power Shield Pty Ltd, its officers, directors, affiliates or employees be liable for any form of indirect, special, consequential or punitive damages, arising out of the use, service or installation, of the products, whether such damages arise in contract or tort, irrespective of fault, negligence or strict liability or whether Power Shield Pty Ltd has been advised in advance of the possibility of such damages. Specifically, Power Shield Pty Ltd is not liable for any costs, such as lost profits or revenue, loss of equipment, loss of use of equipment, loss of software, loss of data, costs of substitution, claims by third parties, or otherwise.
14. Our products come with guarantees that cannot be excluded under the Australian Consumer Law. You are entitled to a replacement or refund for a major failure and compensation for any other reasonably foreseeable loss or damage. You are also entitled to have the products repaired or replaced if the products fail to be of acceptable quality and the failure does not amount to a major failure.
15. Warranty period commences from the date Power Shield invoices the goods  
ZapGuard Range: 1 year  
CompuGuard, SafeGuard, Defender, Commander, Centurion: 2 years  
Platinum Range: 1 year  
Gamatronic Range: 1 year

**To claim a warranty our contact details are as follows**

Call Service on 1300-305-393

Or

Visit [www.powershield.com.au/rmaform/](http://www.powershield.com.au/rmaform/) to process an RMA

Or

Power Shield Pty Ltd (Head Office)  
U3, 205 Camboon Rd  
Malaga, WA 6090

Any claim for expenses must be provided to us in writing and should be sent to our office, detailed above.